

# WeldFil Compact

Art. No.: 34 65



## Applications

- High levels of smoke and dust
- Welding and grinding shops
- Training centres and robotic welding lines
- Laser, plasma and flame cutting systems
- Can be installed outdoors

## Benefits

- Contamination-free dust collection due to compressed air fixation of dust collection containers
- Uninterrupted continuous operation due to automatic differential pressure-controlled filter cleaning
- Little noise emission due to a low noise level
- Quick and simple set up, delivered ready to plug in with forklift pockets and lifting eyes \*1
- Considerable energy cost savings by using the automatic extraction volume control
- Flexible integration of the control system into third-party systems such as cutting equipment due to potential-free contacts \*2
- Best health protection for employees by use of KemTex® ePTFE cartridges with surface filtration

## Properties

- Automatic filter cleaning, pressure-controlled
- Control via touch screen
- W3/IFA certified
- KemTex® ePTFE filter cartridges
- Dust collection container with pneumatic lifting device
- Automatic extraction volume control (optional)

## Accessories

- Automatic dust disposal - DustEvac
- Automatic extraction volume control
- External On/Off
- Fleet management, remote maintenance and pre-noise maintenance using autarkic networking via mobile radio to the KEMPER cloud
- Spark separator – SparkTrap
- Weatherproof housing for outdoor installation



## Technical Data

### Filter

Filter stages	1
Filter method	Cleanable filter
Filter cleaning method	Rotating nozzle
Filter surface	10 m <sup>2</sup>
Number filter elements	9
Filter surface total	90 m <sup>2</sup>
Type of filter	Filter cartridge
Filter material	ePTFE membrane
Filter efficiency	> 99.99 %
Dust classification	M

### Basic data

Extraction capacity	4500 - 6480 m <sup>3</sup> /h
Vacuum	2300 - 1750 Pa
Weight	790 kg
Motor power	5,5 kW
Power supply	3 x 400 V / 50 Hz
Rated current	10.7 A
Noise level	65 dB(A)

### Additional information

Fan type	Radial fan, belt driven
Compressed air supply	5 - 6 bar
Air outlet	450 mm
Air intake	450 mm
Capacity Dust collection container	192 l

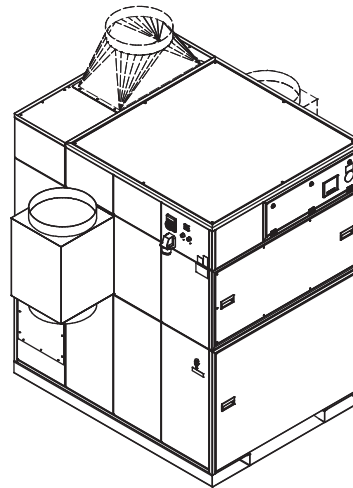
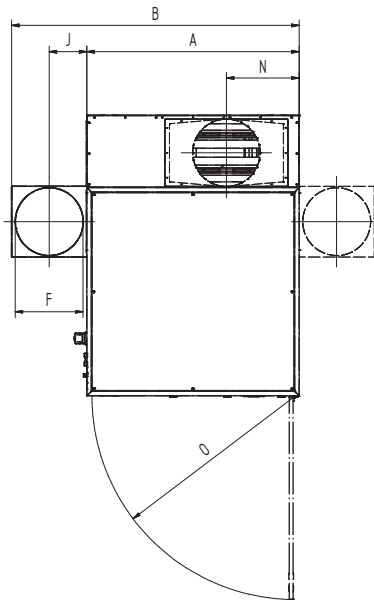
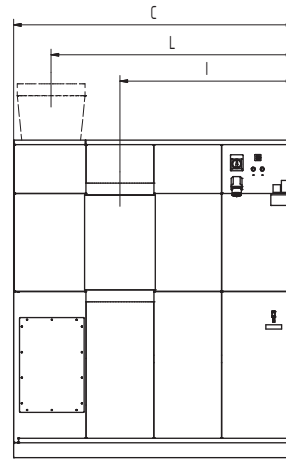
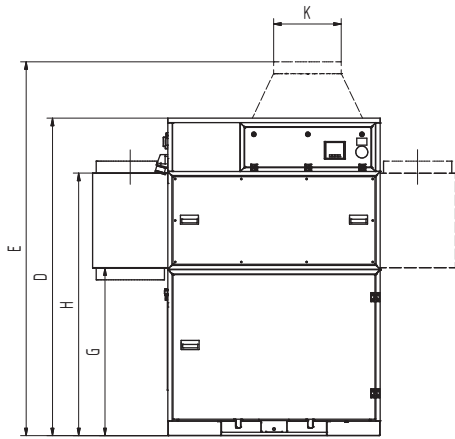

## Technical Data

### Dimensions

A	1413 mm
B	1913 mm
C	1864 mm
D	2110 mm
E	2510 mm
F	450 mm
G	1146 mm
H	1716 mm
I	1157 mm
J	235 mm
K	450 mm
L	1616 mm
N	484 mm
O	1347 mm

The shown transition pieces are optional

# Pressure-volume graph

- Fan characteristic curve
- Working pressure increase
- ▨ Recommended Use

