

MaxiFil AC

Art. No.: 65 650 AK 100



Technical Data

Filter	
Filter stages	3
Filter method	Storage Filter
Filter surface	34 m ²
Type of filter	Safe Change Filter
Filter material	Non-woven polyester
Filter efficiency	> 99,5 %
Filter class	E12
Additional filters	Pre-filter (aluminum) and activated charcoal filter
Basic data	
Extraction capacity	950 m ³ /h
Maximum vacuum	3200 Pa
Weight	135 kg
Motor power	1.5 kW
Power supply	3 x 400 V / 50 Hz
Rated current	3.1 A
Control voltage	24 V, DC
Noise level	70 dB(A)
Additional information	
Fan type	Radial fan
Quantity of extraction arms	1
Exhaust arm type	flexible exhaust arm
Diameter extraction arm	150 mm
Length of exhaust arm	2 m

Applications

- Absorption of gases and odors
- Medium levels of smoke and dust
- Regular use

Benefits

- Safe operation by rotation field control
- Exhaust arm requires less adjustment due to flow-optimised exhaust hood design
- Increased safety due to filter monitoring
- Increased safety with safe filter change
- Very economic due to long lasting high capacity filters

Properties

- Exhaust arm up to 4 m
- Activated carbon filter with 7.8 kg filling volume
- Rotating exhaust hood

Accessories

- Automatic start-stop
- Workplace lighting incl. on/off switch at the hood

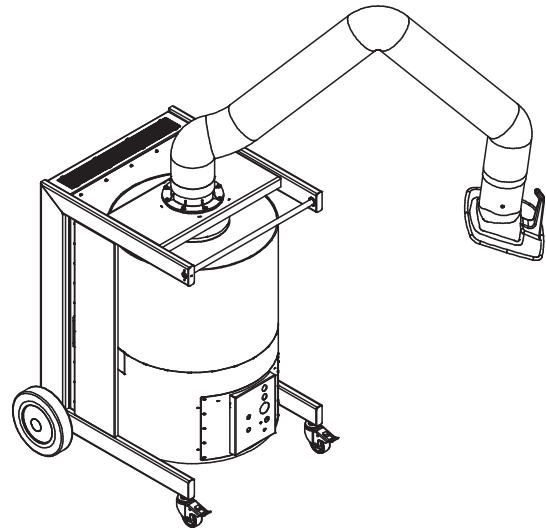
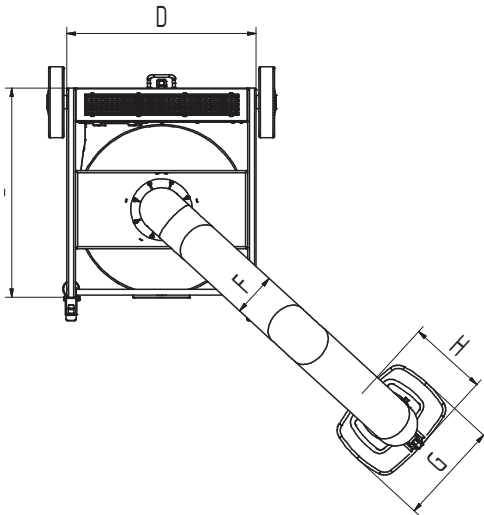
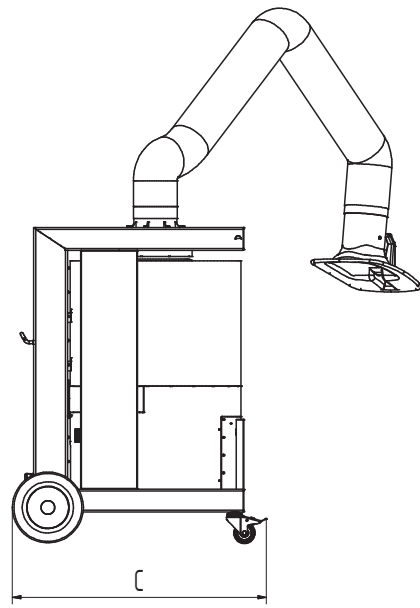
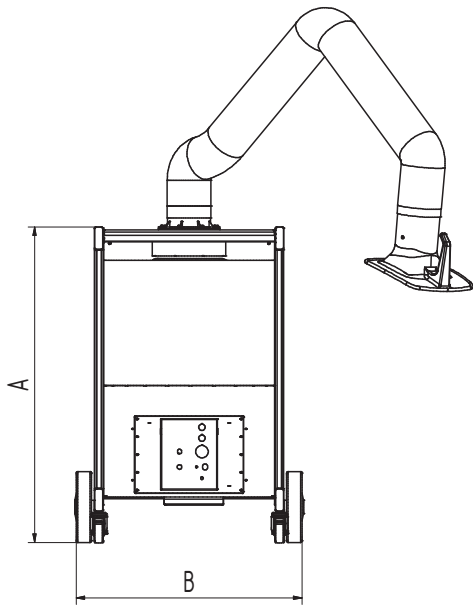

Technical Data

Dimensions

A	1109 mm
B	803 mm
C	892 mm
D	665 mm
E	738 mm
F	150 mm
G	360 mm
H	295 mm