

MaxiFil Stationary

Art. No.: 65 850 111



Technical Data

Filter	
Filter stages	2
Filter method	Storage Filter
Filter surface	42 m ²
Type of filter	Safe Change Filter
Filter material	Non-woven polyester
Filter efficiency	> 99.5 %
Filter class	E12
Additional filters	Pre-filter
Basic data	
Extraction capacity	1000 m ³ /h
Maximum vacuum	3200 Pa
Dimensions (w x t x h)	1533 x 776 x 1228.5 mm
Weight	125 kg
Motor power	1.5 kW
Power supply	3 x 400 V / 50 Hz
Rated current	3.1 A
Control voltage	24 V, DC
Noise level	72 dB(A)
Additional information	
IFA-Certification	W3-Approved
Fan type	Radial fan
Quantity of extraction arms	1
Exhaust arm type	rigid metal tube arm
Diameter extraction arm	150 mm
Length of exhaust arm	7 m

Applications

- Suitable for all materials, including high-alloy steel
- Medium levels of smoke and dust
- Regular use

Benefits

- Safe operation by rotation field control
- Increased safety due to filter monitoring
- Increased safety with safe filter change
- Convenient unit operation due to control box

Properties

- 360 degrees rotating exhaust hood with damper
- W3/IFA certified
- Arm from 5 m with boom
- Silencer
- Control box

Accessories

- Automatic start-stop
- Workplace lighting incl. on/off switch at the hood



Suitable for alveole exchangeable dusts
separation > 99 % of particles < 0,4 µm

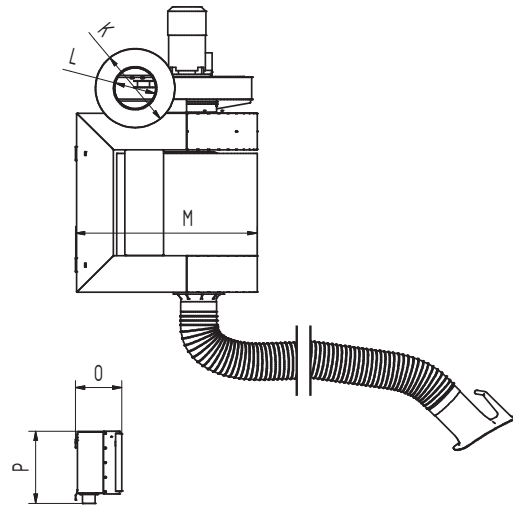

Technical Data

Dimensions

A	818 mm
B	715 mm
C	631.5 mm
D	479 mm
E	118 mm
F	1228 mm
G	660 mm
H	388 mm
I	270 mm
J	26 mm
K	340 mm
L	NW180 mm
M	776 mm
O	198.5 mm
P	310 mm

